

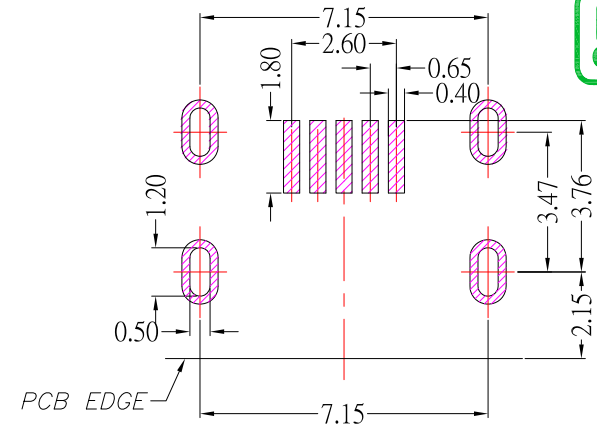

# MRUSB-5B-D17xx-S347

Shell Material : SHELL 鍍層:

Blank : BRASS	TN
A : SUS	NI

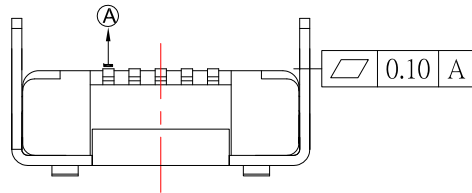

P.C.B LAYOUT MOUNTING PATTERN

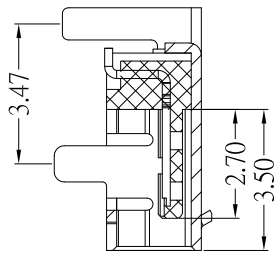

SECTION A-A

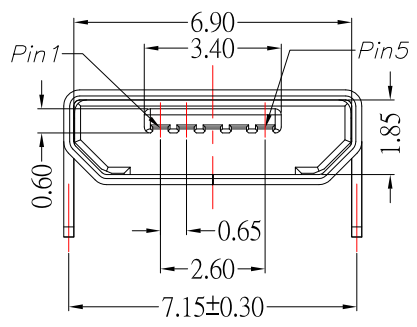
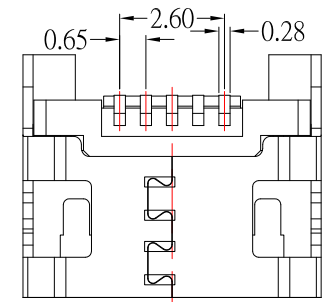
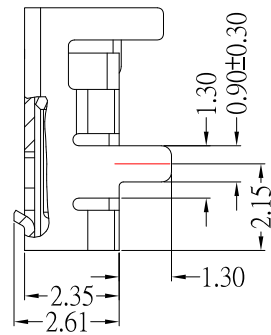
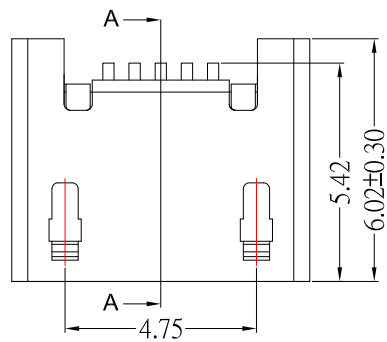

NOTES:

- 1.MATERIAL:
  - 1.1 HOUSING: LCP,UL94V-0
  - 1.2 CONTACT: PHOSPHOR BRONZE
  - 1.3 SHELL: BRASS / SUS
- 2.Finish:
  - 2.1 Contact: Plated Gold in Mating Area ;  
Gold Plated on Solder Balls ;  
Nickel under plated overall
  - 2.2 SHELL: NICKEL or TIN UNDER PLATED SURFACE LAYER
- 3.SPECIFICATION:
  - 3.1 CURRENT RATING: 1.8 A Max(PIN1,5)  
1.0 A Max(PIN2,3,4)
  - 3.2 DIELECTRIC WITHSTANDING VOLTAGE: 100 V(ac) FOR 1min
  - 3.3 CONTACT RESISTANCE: 30 mΩ MAX.
  - 3.4 INSULATION RESISTANCE: 100 MΩ MIN.
  - 3.5 TOTAL MATING FORCE: 3.57 KgF MAX.
  - 3.6 TOTAL UNMATING FORCE: 1.0 KgF MIN.
  - 3.7 TEMPERATURE RANGE: -30°C ~ +80°C

**CONTACT** 建倚科技股份有限公司  
CONTACT TECHNOLOGY CORP.

TOLERANCE UNLESS OTHERWISE STATED :	Up to 5	±0.2
	Above 5 ~ 15	±0.3
	Above 15 ~ 30	±0.4
	Above 30 ~ 50	±0.5
	Angle	±0.3

3RD. ANGEL'S



UNITS MM

DRAWN BY:	DATE	MAT'L	TITLE	CONNECTOR
Jack Lu	03/11/19			
CHECKED BY:	DATE	FINISH	MODLE	MICRO USB 5BF 無捲邊 SHELLED DIP TYPE
Jacky Chen	03/11/19			
APPROVED BY:	DATE	SCALE	DWG NO.	MRUSB-5B-D17xx-S347
Tony Kao	03/11/19	1 : 1	PART NO.	MRUSB-5B-D17xx-S347
		SHEET NO.	1 of 1	SIZE A4
				VER R3

ITEM NO.	DESCRIPTION	DRAWN	DATE
3	更新尺寸	Jack	031119
2	更新為A0版	Jack	052217
1	新增材質選項	Jack	051117